

EKB+PKDO

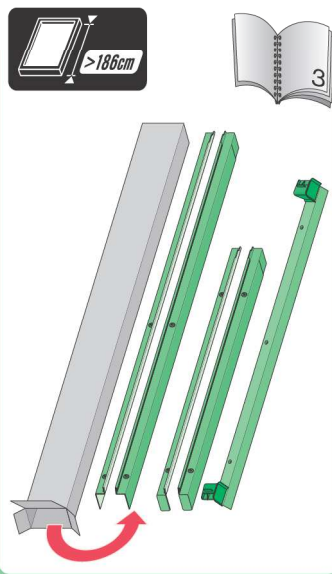

EKB Thermo+PKDO

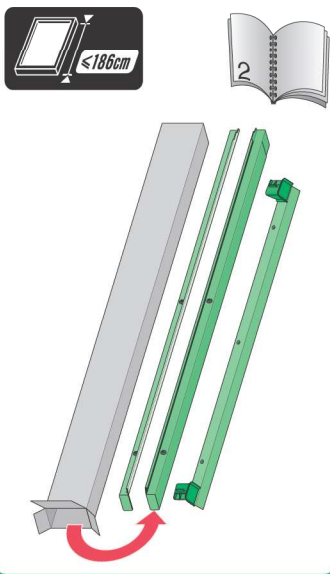
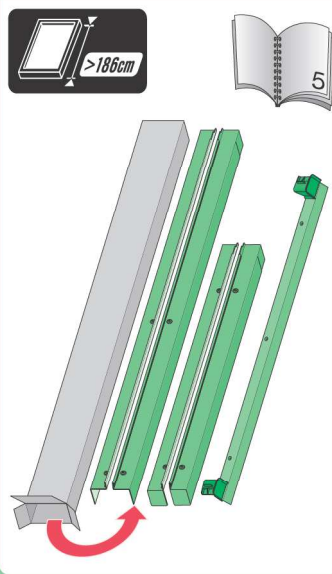
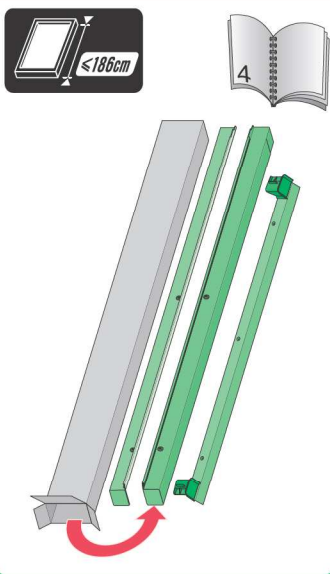

EKB J+PKDO

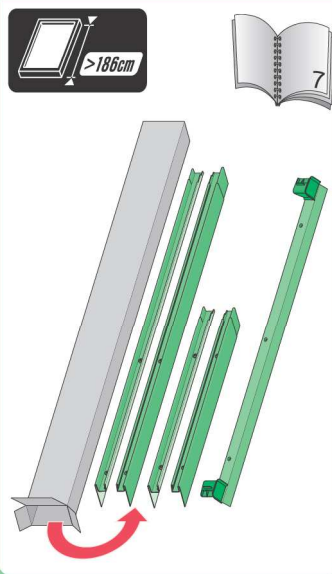
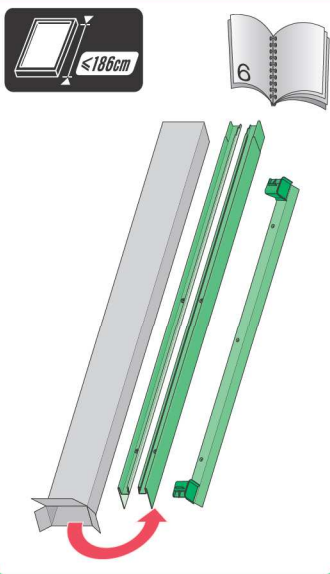

EKB+PKDO

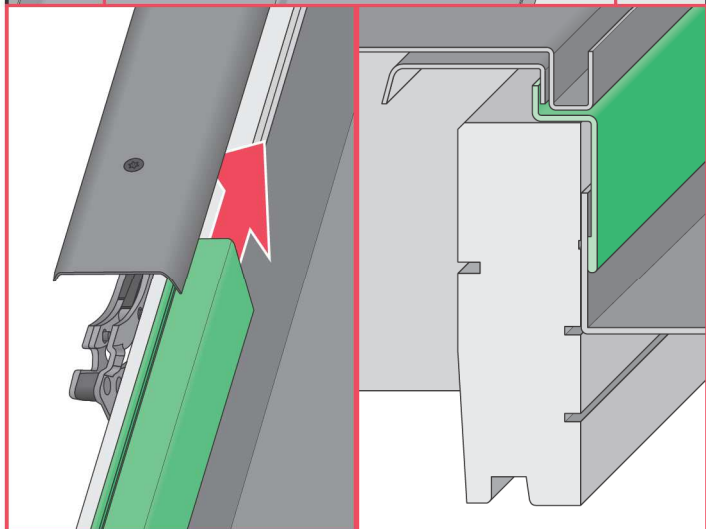
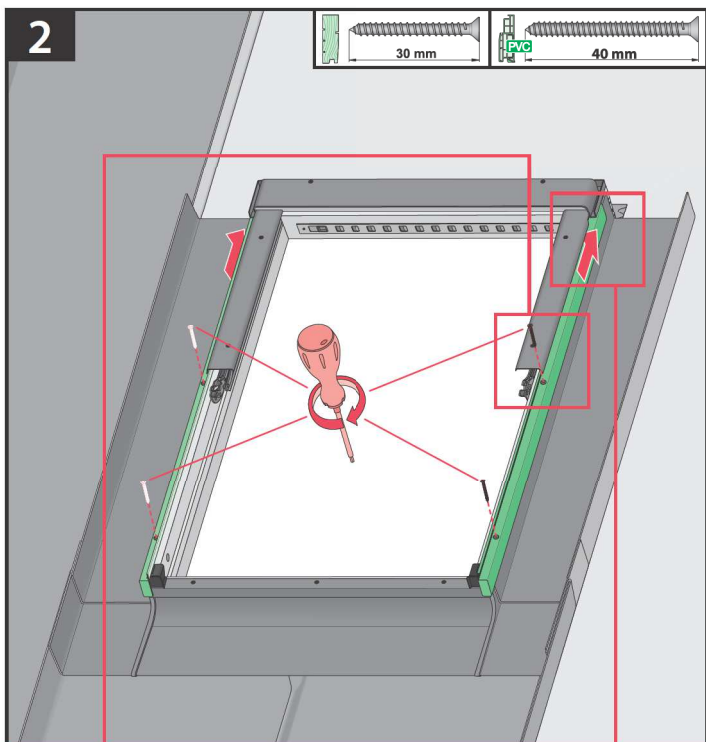
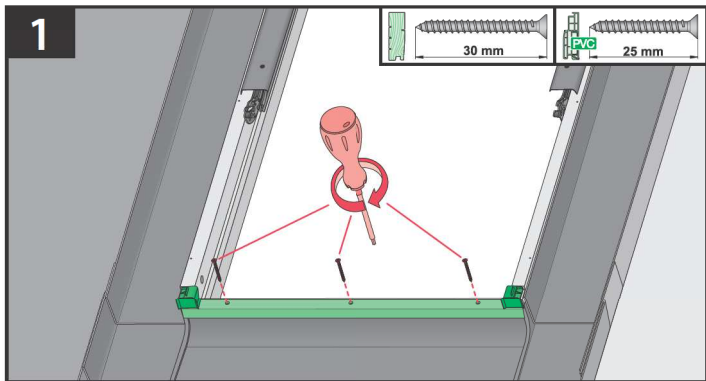
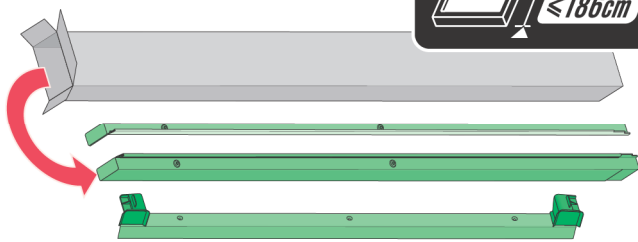

EKB+PKDO

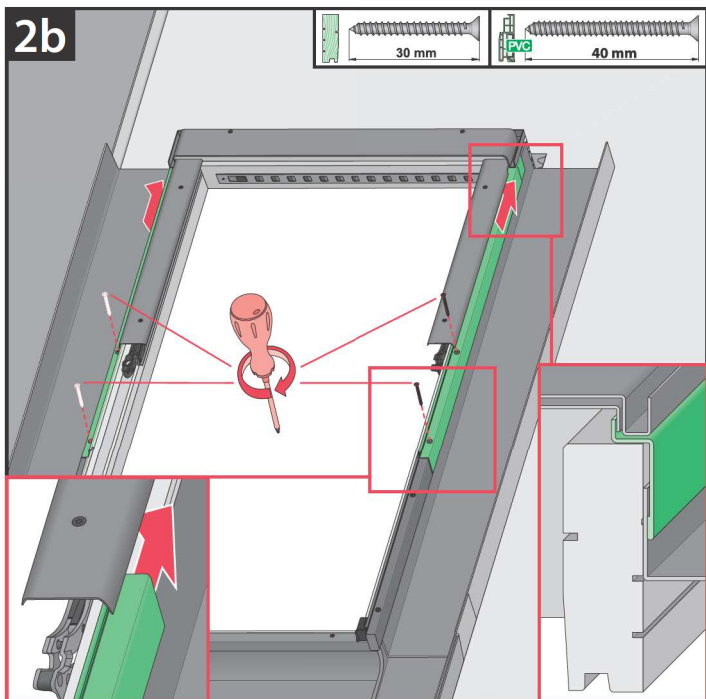
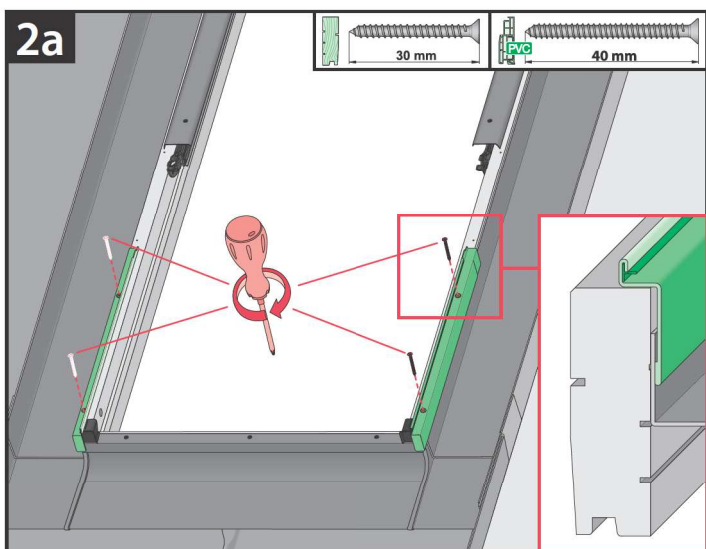
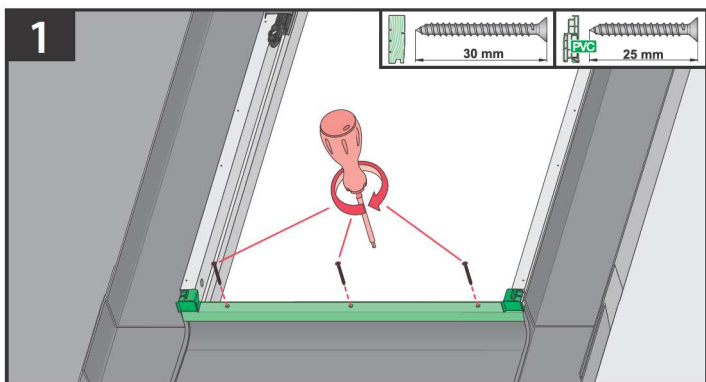

EKB Thermo+PKDO

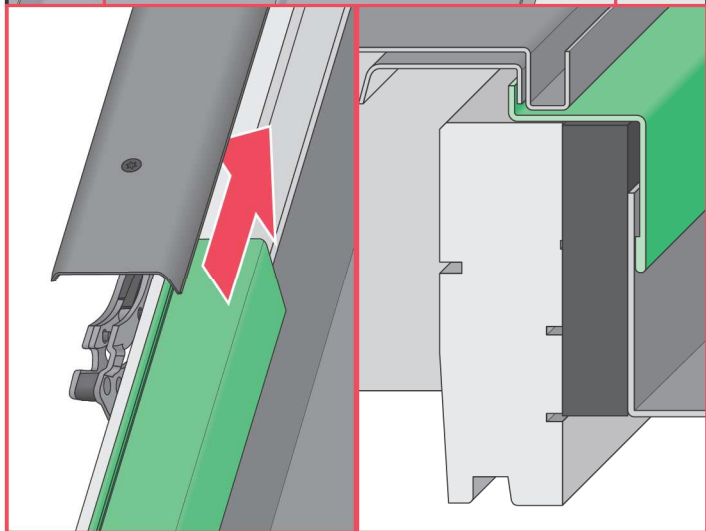
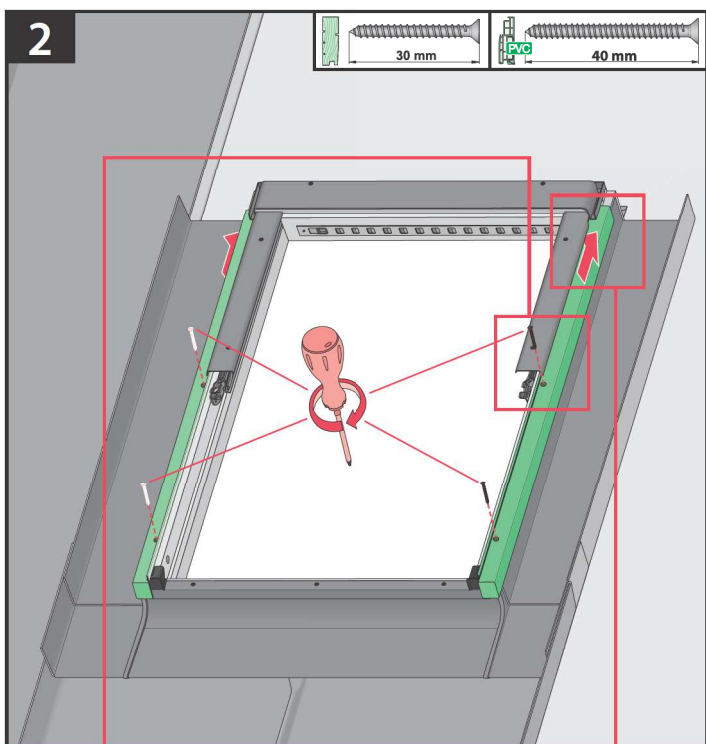
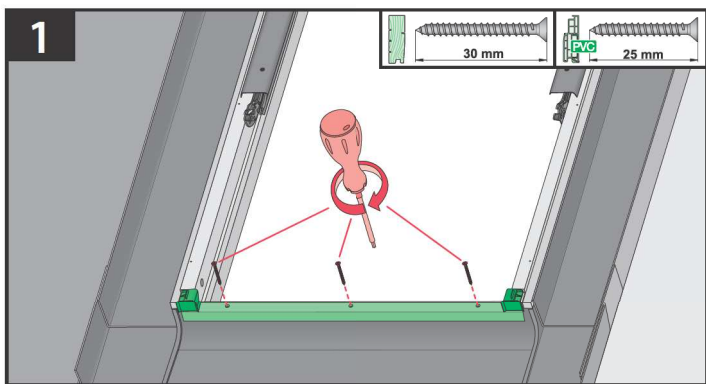
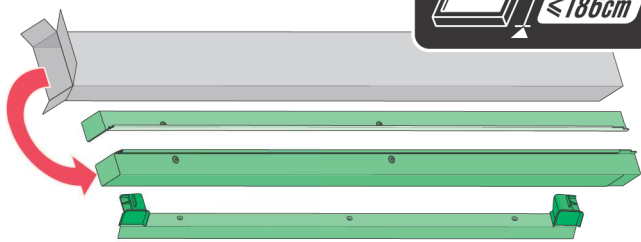

EKB Thermo+PKDO

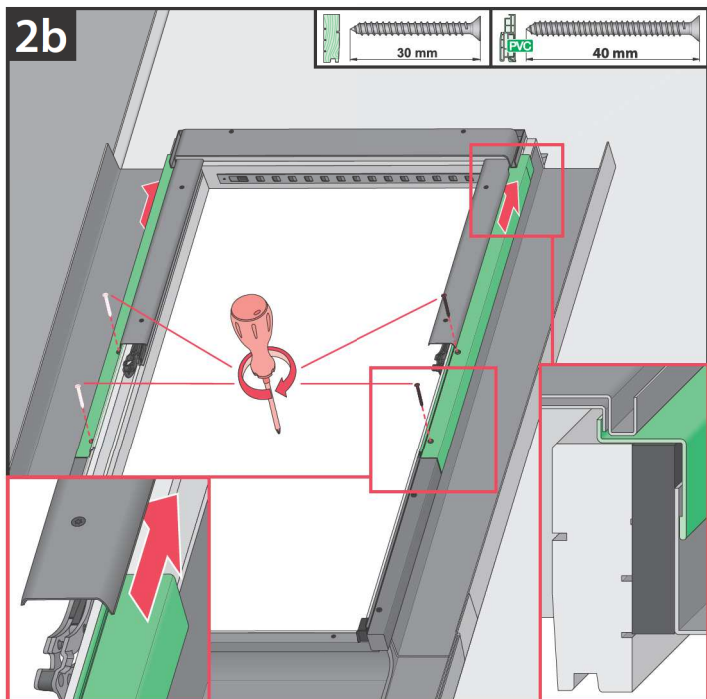
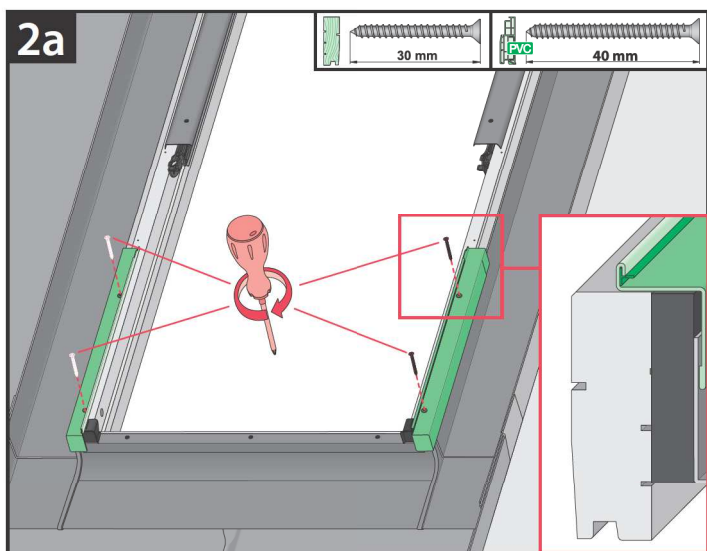
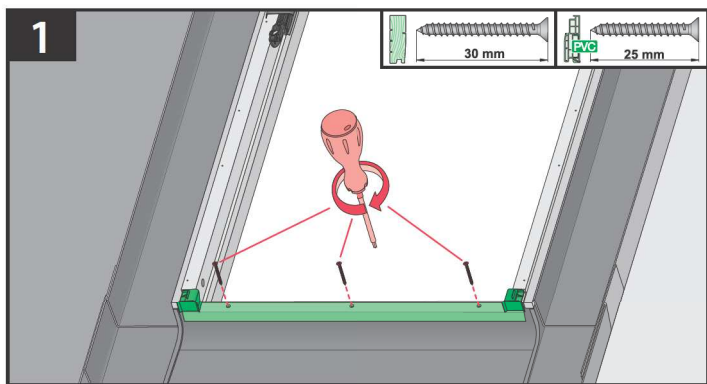
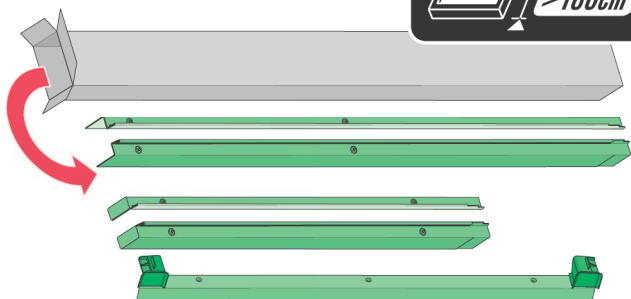

EKB J+PKDO

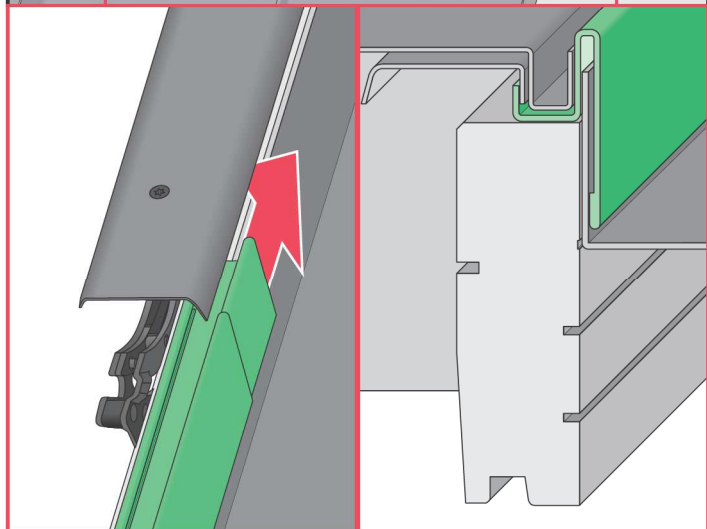
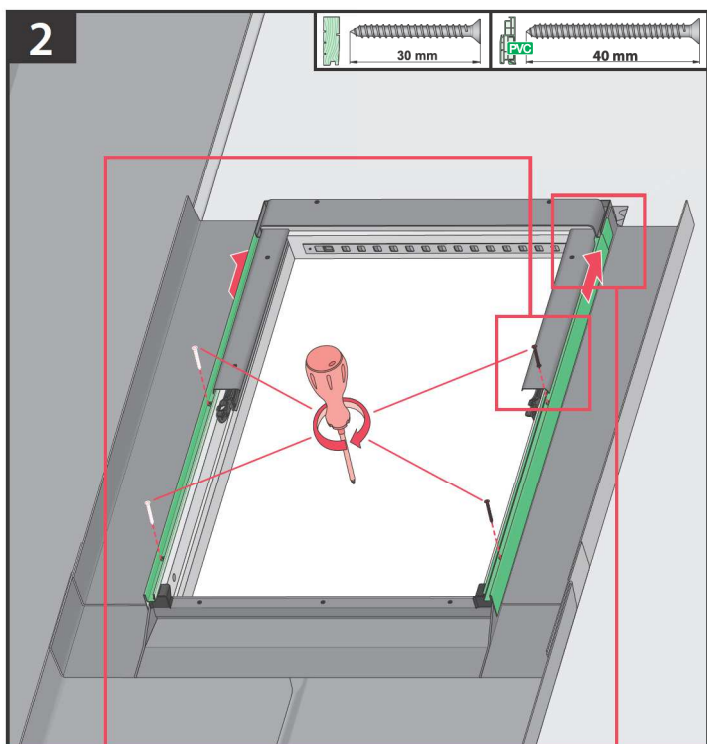
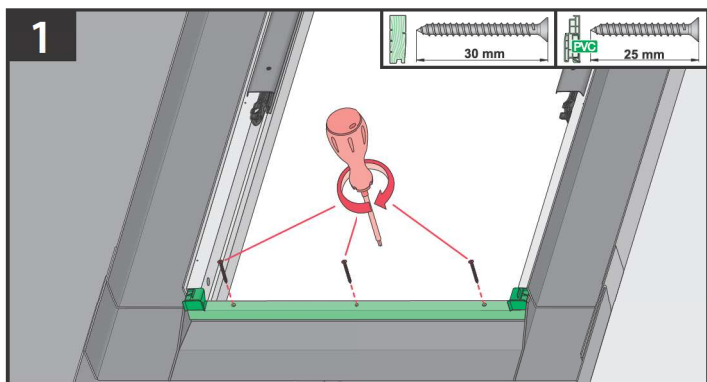
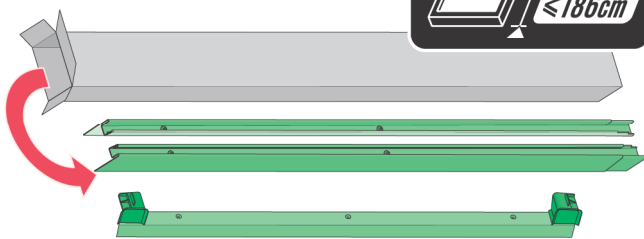

EKB J+PKDO

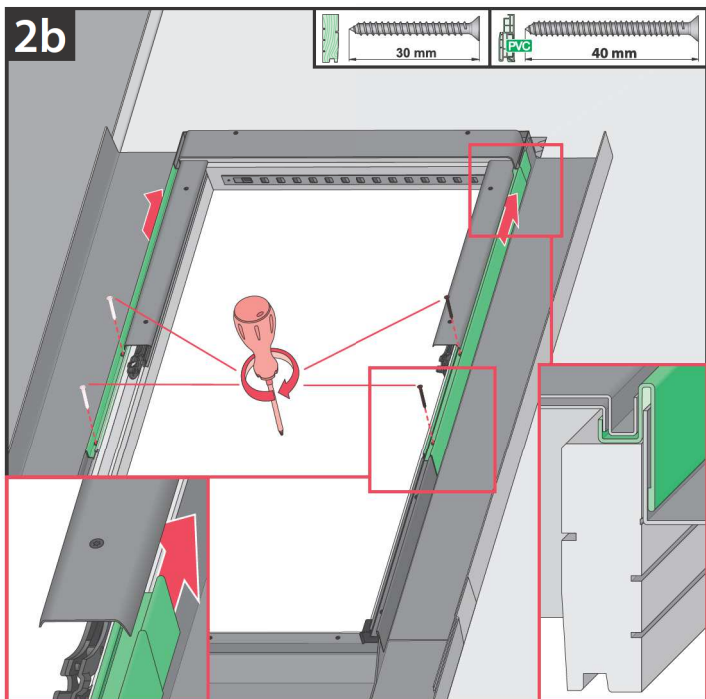
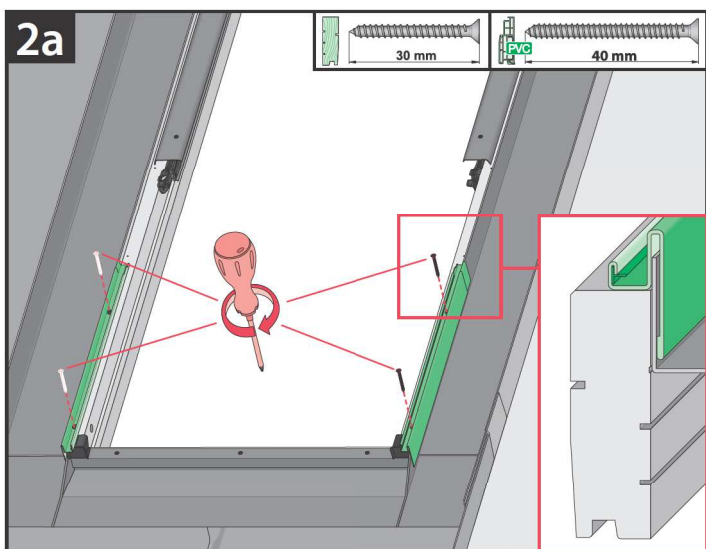
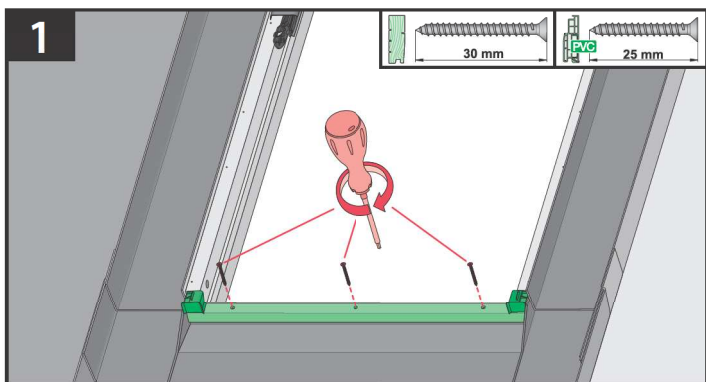

0 [cm] 1 2 3 4 5 6 7 8 9 10 11 12 13 14 15 16 17 18 19 20

BG	Производител и Продавач не носят отговорност за неспазване на съответните закони, строителни норми и изисквания за безопасност от потребителя на продукта, архитекта, монтажника или собственика на сградата.	LT	Ražotajs un mazumtirgotājs neuzņemas atbildību par likumi, noteikumi un drošības prasību neievērošanu no produkta lietotāja, arhitekta, uzstādītāja vai ēkas īpašnieka puses.
CZ	Výrobce ani prodejce nenesou žádnou odpovědnost za nedodržení příslušných platných zákonů, stavebních předpisů a bezpečnostních požadavků uživatelem výrobku, architektem, montážníkem nebo vlastníkem budovy.	LV	Ģarantors ir pārdevējs neņems nekādu atbildību uz tai, kad gaminio naudotojās, arhitekstās, montāzistās ar pastato svininikas nesīlako gallojancu īstatymu, taisykliu ir saugos reikalavimū.
DE	Hersteller und Verkäufer übernehmen keine Haftung für Nichtbeachtung entsprechender Rechts- und Bauvorschriften sowie Sicherheitsanforderungen seitens Produktbenutzers, Architekten, Monteurs oder Gebäudebesitzers.	NL	De fabrikant en verkoper zijn niet aansprakelijk voor gevolgen bij het niet opvolgen van toepasselijke wetten, bouwbesluiten en veiligheidsvoorschriften door de gebruiker van het product, de architect, de installateur of de eigenaar van het gebouw.
EE	Tootja ja jaemüüja ei vastuta toote kasutaja, arhitekti, paigaldaja või hoone omaniku poolt kehtivate seaduste, määruste ja ohutusnõuete mittejärgmise eest.	PL	Producent i Sprzedawca nie ponosi żadnej odpowiedzialności za nieprześcieżenie stosownych przepisów prawa, przepisów budowlanych i wymogów bezpieczeństwa przez użytkownika produktu, architekta, montażystę lub właściciela budynku.
ES	El fabricante y el vendedor no tienen ninguna responsabilidad por el incumplimiento de la ley vigente, normas de construcción y exigencias de seguridad por parte del usuario del producto, arquitecto, instalador o el propietario del edificio.	PT	O fabricante e o vendedor não tem nenhuma responsabilidade pelo o não cumprimento da lei, códigos de construção e as exigências de segurança por parte do usuário do produto, arquiteto, instalador ou proprietário do edifício.
FR	Le fabricant et le revendeur ne prend aucune responsabilité de ne pas respecter les lois applicables, les règlements sur les bâtiments et les exigences de sécurité par l'utilisateur du produit, l'architecte, l'installateur ou le propriétaire du bâtiment.	RO	Nici producătorul, nici distribuitorul nu își vor asuma niciun fel de răspundere pentru nerespectarea legilor în vigoare, a legilor din domeniul construcțiilor sau a măsurilor de siguranță impuse utilizatorilor produsului, arhitecților, montajitorilor sau proprietarilor clădirii.
GB	Manufacturer and Seller shall bear no liability for failure to comply with the applicable laws, building codes and safety requirements by the user of the product, architect, fitter or owner of the building.	RU	В случае несоблюдения архитектором, монтажником или владельцем здания строительных правил и норм безопасности ответственность с производителя и продавца снимается.
HU	A Gyártó és a Forgalmazó nem vállal semmiféle felelősséget a vonatkozó törvények, építési és biztonsági előírások, termékhelyhasználó, építész, beépítőmester vagy épülettulajdonos általi be nem tartásáért.	SK	Výrobca a predajca nenesi žiadnu zodpovednosť za nedodržanie príslušných ustanovení zákona, stavebných predpisov a bezpečnostných požiadaviek užívateľom výrobku, architektom, montážom alebo majiteľom objektu.
IT	Il Produttore e il Rivenditore non potranno essere ritenuti responsabili per il mancato rispetto, da parte dell'utente del prodotto, del progettista, dell'installatore o del proprietario dell'edificio, delle leggi vigenti, nonché dei regolamenti edilizi e di quelli relativi alla sicurezza.		